

# Potain MC 475

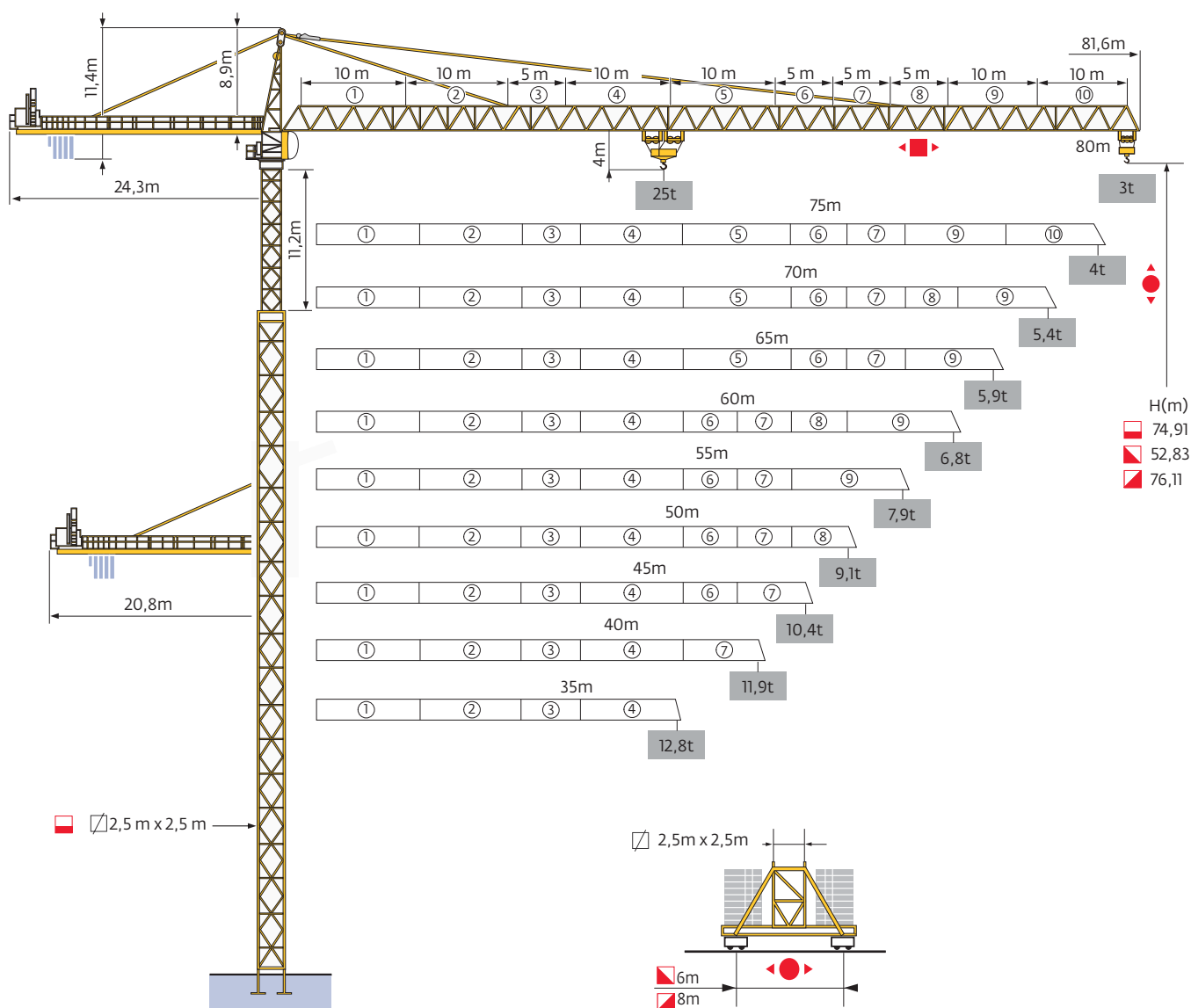

Mât - Réactions / Mast - Reaktionskräfte / Mast - Reactions / Mástil - Reacciones / Torre - Reazioni  
 Tramo - Reações / Реакция опор мачты

2,5 m

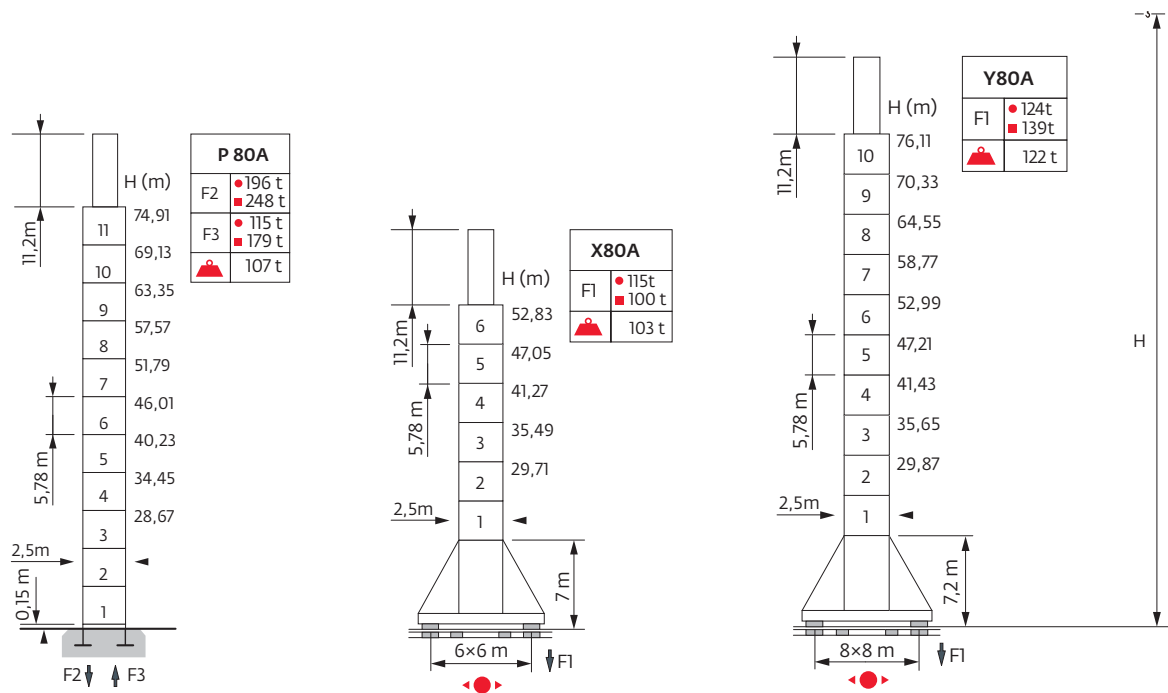

Ancrages / Verankerungen / Anchorages / Anclajes / Ancoraggi  
 Ancoragem / Анкера

P 80A

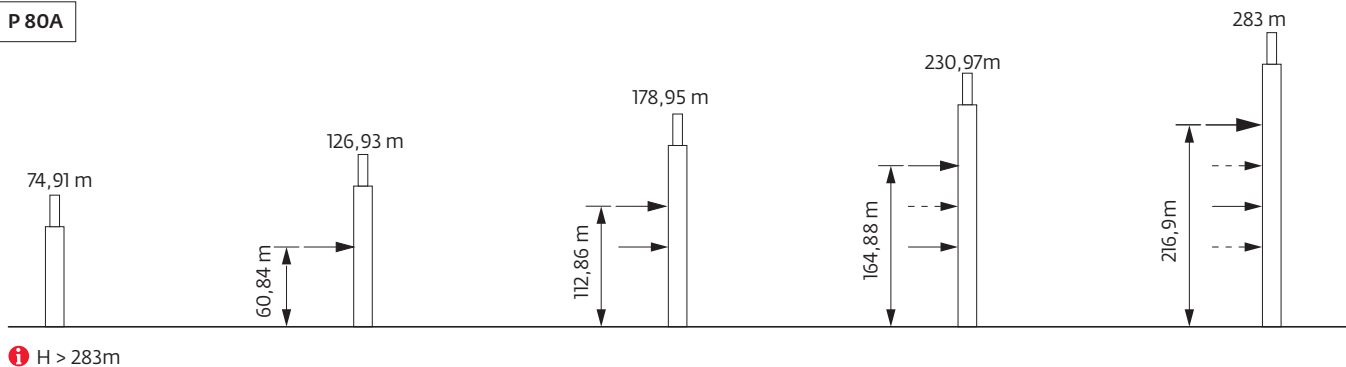

Courbes de charges / Lastkurven / Load curves / Curvas deargas / Curve di carico  
 Curvas de carga / Кривые нагрузок



80m	3,1	▶	14,3	15	17	20	22	25	25,2	27,2	30	32	35	40	45	50	55	60	65	70	75	80	m
▲▲▲▲			25	23,6	20,3	16,7	14,8	12,6	12,5	12,5	11,1	10,3	9,3	7,9	6,8	5,9	5,2	4,6	4,2	3,7	3,4	3	t
75 m	3,1	▶		15,6	17	20	22	25	27	27,7	29,9	32	35	40	45	50	55	60	65	70	75		m
▲▲▲▲				25	22,6	18,6	16,6	14,2	12,9	12,5	12,5	11,6	10,4	8,9	7,7	6,8	6	5,3	4,8	4,3	4		t
70 m	3,1	▶			18	20	22	25	27	30	32,3	34,8	35	40	45	50	55	60	65	70			m
▲▲▲▲					25	22,2	19,8	17,1	15,6	13,7	12,5	12,5	12,4	10,7	9,3	8,2	7,3	6,6	5,9	5,4			t
65 m	3,1	▶			18,1	20	22	25	27	30	32,4	34,9	35	40	45	50	55	60	65				m
▲▲▲▲					25	22,2	19,9	17,1	15,6	13,7	12,5	12,5	12,5	10,7	9,3	8,2	7,3	6,6	5,9				t
60 m	3,1	▶			18,7	20	22	25	27	30	32	33,4	36,1	40	45	50	55	60					m
▲▲▲▲					25	23,1	20,7	17,8	16,2	14,3	13,2	12,5	12,5	11,1	9,7	8,5	7,6	6,8					t
55 m	3,1	▶			19,3	20	22	25	27	30	32	34,6	37,4	40	45	50	55						m
▲▲▲▲					25	24	21,5	18,5	16,9	14,9	13,8	12,5	12,5	11,6	10,1	8,9	7,9						t
50 m	3,1	▶			19,6	20	22	25	27	30	32	35,1	37,9	40	45	50							m
▲▲▲▲					25	24,4	21,8	18,8	17,2	15,1	14	12,5	12,5	11,7	10,2	9,1							t
45 m	3,1	▶			19,7	20	22	25	27	30	32	35,4	38,2	40	45								m
▲▲▲▲					25	24,6	22,1	19	17,3	15,3	14,1	12,5	12,5	11,9	10,4								t
40 m	3,1	▶			19,9	20	22	25	27	30	32	35,6	38,4	40									m
▲▲▲▲					25	24,8	22,2	19,1	17,5	15,4	14,3	12,5	12,5	11,9									t
35 m	3,1	▶			20	22	25	27	30	32	35												m
▲▲▲▲					25	22,4	19,3	17,6	15,5	14,3	12,8												t

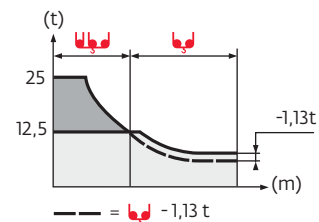

Lest de base / Grundballast / Base ballast / Lastre de base / Zavorra di base  
 Lastro da base / Базовый Балласт

2,50 m	X80A	H (m)	52,83	47,05	41,27	35,49	29,71				
		(t)	96	96	96	96	96				
2,50 m	Y 80A	H (m)	76,11	70,33	64,55	58,77	52,99	47,21	41,43	35,65	29,87
		(t)	96	84	60	60	60	60	60	60	60

Lest de contre-flèche / Gegenauslegerballast / Counter-jib ballast / Lastre de contra-flecha / Zavorra di controbraccio  
 Lastro da contra lança / Противовес стрелы



	4000 kg	6000kg	(kg)
80m	0	5	30000
75 m	1	4	28000
70 m	1	4	28000
65 m	2	3	26000
60 m	1	3	22000
55 m	2	2	20000
50 m	2	3	26000
45 m	1	3	22000
40 m	2	2	20000
35 m	1	2	16000

CBD - 4000 kg

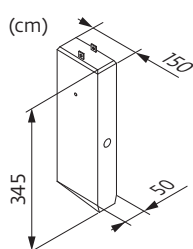
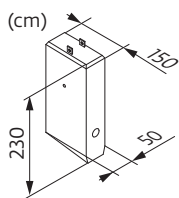

CBC - 6000kg



Encombremet et poids / Abmessungen und Gewicht / Dimensions and weight / Dimensiones y peso / Ingombro e peso  
dimensões e pesos / габаритные размеры и вес

Partie tournante / Drehender Kranteil / Slewing crane part / Parte giratoria  
Parte rotante / Parte rotativa / Поворотная часть :  80 m -  100 LVF

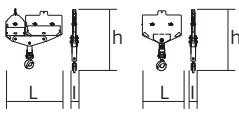
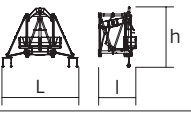
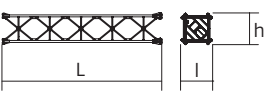
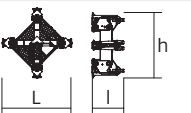
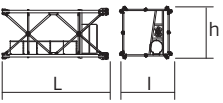
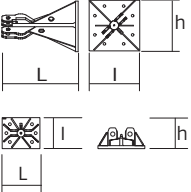
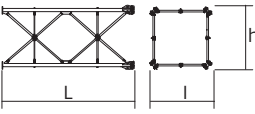
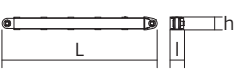
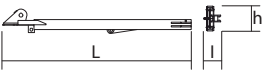
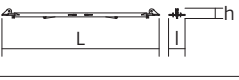
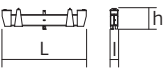
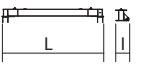

Partie tournante / Drehender Kranteil / Slewing crane part Parte giratoria / Parte rotante / Parte rotativa Поворотная часть	L (m)	l (m)	h (m)	kg (+/- 5%)	
Contre-flèche / Gegenausleger Counter-jib / Contra-flecha Controbraccio / Contra-lança Контр-стрела		10,925	2,1	0,8	3550
		4,0	1,95	0,7	950
		8,3	1,9	0,7	1,95
Porte-flèche / Auslegerträger Cathead / Porta-flecha Cuspide / Suporte de lança Оголовок		11,95	2,1	2,52	7400
cabine / Kabine cab / cabina cabina / cabina кабина	 V140S	3,4	1,9	2,57	1130
Pivot / Krankopf Towerhead/ Pivote Portaralla / Pivot Секция поворотной части	 RVF183	2,56	2,81	2,54	8530
Treuil de levage (+ câble) / Hubwerk (+ Seil) Hoisting winch (+ rope) / Mecanismo de elevación (+ cabo) Argano di sollevamento (+ fune) Guincho de elevação (+ cabo) Подъемная лебедка (+ канатом)	 100 LVF	3,18	1,6	1,88	4455
Elément de flèche / Auslegerelement Jib section / Elemento de flecha Elemento di braccio / Elemento de lança Секция стрелы	 ①	10,2	2,02	2,36	3212
Elément de flèche / Auslegerelement Jib section / Elemento de flecha Elemento di braccio / Elemento de lança Секция стрелы	 ②	10,355	1,9	2,252	3680
	 ④	10,345	1,9	2,232	2105
	 ⑤	10,454	1,9	2,219	1825
	 ⑨	10,149	1,9	1,986	1270
	 ⑩	10,126	1,9	1,95	895
Elément de flèche / Auslegerelement Jib section / Elemento de flecha Elemento di braccio / Elemento de lança Секция стрелы	 ③	5,351	1,9	2,245	1445
	 ⑥	5,345	1,9	2,221	1015
	 ⑦	5,337	1,9	2,248	1150
	 ⑧	5,197	1,9	1,997	760
Chariot / Laufkatze Trolley / Carrello Carro / Carro-distribuidor Тележка	  25t	4,1	2,19	1,16	1195
Chariot / Laufkatze Trolley / Carrello Carro / Carro-distribuidor Тележка	  12,5t	2,14	2,19	1,16	645

Partie tournante / Drehender Kranteil / Slewing crane part Parte giratoria / Parte rotante / Parte rotativa Поворотная часть		L (m)	I (m)	h (m)	kg (+/- 5%)	
Moufle / Hubflasche Pulley block / Aparejo Bozzello / Cadernal Полиспаст		1,83 1,18	0,34 0,22	2,34 1,95	905 450	
<b>Équipement de télescopage / Teleskopierausrüstung / Telescoping equipment Equipo de telescopaje / Equipaggiamento di telescopaggio / Equipamento de telescopagem Оборудование для телескопирования</b>						
Cage de télescopage / Teleskopwagen Telescopic cage / Jaula de telescopaje Gabbia di telescopaggio / Gaiola de telescopagem для телескопирования крана		∇2,5 m	7,4	3,66	5,83	6200
Coulisse / Gleitstück Slider / Corredera Scorrimento / Tramo interior de telescopagem выдвижная мачта		∇2,5 m	11,08	2,1	2,1	7100
Bas de coulisse / Gleitstückunterteil Slider base / Parte baja de corredera Parte inferiore di scorrimento Base do tramo interior de telescopagem основание выдвижной мачты		∇2,5 m	2,35	1,58	2,35	5960
<b>Mâture / Mastwerk / Masts Mástil / Torre / Coluna Мачты</b>						
R 87		5,98	2,90	2,90	4350	
R 86		5,98	2,90	2,90	4050	
<b>Bases / Kranbasen / Crane bases Bases / Basi / Bases фундамент под кран</b>						
Pieds de scellement / VerankerungsfüÙe Fixing angles / Pie de empotramiento Montante da annegare / Angulos fixadores анкера		P 80A	1,21	0,8	0,8	1970
		R 80A	0,68	0,56	0,3	830
Mât-châssis / Grundmasteinheit Basic mast unit / Tramo-chassis Elemento base / Tramo-chassis Мачта для крепления к шасси		X 80A Y 80A	6,0 6,0	3,0 3,0	3,0 3,0	5600 7400
Haubans / Mastabstütungen Struts / Tornapuntas Puntoni / Escoras Растяжка		X 80A	4,66	0,38	0,30	450
		Y 80A	5,48	0,42	0,37	800
1/2 Longeron / 1/2 Längsträger 1/2 Side member / 1/2 Larguero 1/2 Longherone / 1/2 Longarina 1/2 боковина		X 80A	4,27	0,9	0,54	450
		Y 80A	5,62	1,17	0,60	1000
Longeron / Längsträger Side member / Larguero Longherone / Longarina боковина		X 80A	9,02	0,94	0,54	950
		Y 80A	11,86	1,17	0,60	2100
Support lest / Ballastträger Ballast support / Soporte de lastre Supporto zavorra / Suporte de lastro Опора балласта		X 80A	3,39	0,30	0,63	180
		Y 80A	4,65	0,32	0,66	270
Traverse de châssis / Unterwagentraverse Chassis beam / Traviesa chasis Traversa carro / Travessa chasis балка шасси		X 80A	6,56	0,60	0,79	1400
		Y 80A	8,60	0,70	1,15	2000

Mécanismes / Triebwerke / Mechanisms / Mecanismos / Meccanismi  
 Mecanismos / Механизмы

400 V - 50 Hz											ch - PS hp	kW	
	<b>100 LVF 63 Optima</b>	m/min t	0 → 30 12,5	40 9	57 6	78 2,7	0 → 15 25	20 18	28,5 12	39 5,4	100	75	726m
	<b>RVF183 Optima+</b>	tr/min U/min -rpm	0 → 0,8								3x12	3 x9	
	<b>10DVF 10</b>	m/min	0 → 64 (25 t) - 0 → 100 (12,5 t) - 0 → 110 (6,25 t)								10	7,4	
	<b>X80A Y80A RT 664 A2B-2V</b>	m/min	16 - 32								6 x 7	6 x5,2	

<b>CEI38 </b>	<b>kVA</b>
400 V (+10% -10%) 50 Hz	100 LVF : 133 kVA

480 V - 60 Hz											ch - PS hp	kW	
	<b>100 LVF 63 Optima</b>	m/min t	0 → 30 12,5	40 9	57 6	78 2,7	0 → 15 25	20 18	28,5 12	39 5,4	100	75	726m
	<b>RVF183 Optima+</b>	tr/min U/min -rpm	0 → 0,8								3x12	3 x9	
	<b>10DVF 10</b>	m/min	0 → 64 (25 t) - 0 → 100 (12,5 t) - 0 → 110 (6,25 t)								10	7,4	
	<b>X80A Y80A RT 664 A2B-2V</b>	m/min	19 - 38								6 x 8,4	6 x6,2	

<b> IEC 60204-32</b>	<b>kVA</b>
480 V (+6% -10%) 60 Hz	100 LVF : 135 kVA

## 100 LVF 63 Optima

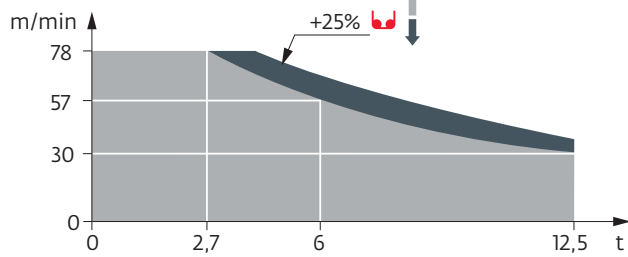

	FR	DE	EN	ES	IT	PT	RU
	Appel de flèche	Auslegerüberhöhung	Jib elevation	Elevación de la flecha	Inclinazione braccio	Desvio da lança	подъем стрелы
	Réactions en service	Reaktionskräfte in Betrieb	Reactions in service	Reacciones en servicio	Reazioni in servizio	Reacções em serviço	Реакция при работе
	Réactions hors service	Reaktionskräfte außer Betrieb	Reactions out of service	Reacciones fuera de servicio	Reazioni fuori servizio	Reacções fora de serviço	Реакция в покое
	A vide sans lest avec flèche et hauteur maximum	Gewicht ohne Last, ohne Ballast, mit Ausleger und max. Höhe	Weight without load, without ballast, with jib and max. height	Peso en vacío sin lastre, con flecha y altura máxima	Peso a vuoto, senza zavorra, con braccio e altezza massimi.	Peso em vazio sem lastro com lança e altura máxima.	Вес пустого, без балласта, со стрелой, максимальной высоты.
	Poids total du lest	Ballast-Gesamtgewicht	Total ballast weight	Peso total del lastre	Peso totale della zavorra	Peso total do lastro	Общий вес балласта
	Camion 13,4 m	Lkw 13,4 m	Lorry 13,4 m	Camión 13,4 m	Camion 13,4 m	Camião 13,4 m	Ррузовой автомобиль 13,4 м
	Conteneur High Cube 40"	Container High Cube 40"	Container High Cube 40"	Contenedor High cube 40"	Container High Cube 40"	Contentor 40"	Контейнер повышенной вместимости длиной 40"
	Cadre d'ancrage serré	Fester Verankerungsrahmen	Tightened anchorage frame	Marco de anclaje de apriete	Quadro di ancoraggio stretto	Quadro de amarração apertado	Прикрепленная анкерная рама
	Cadre d'ancrage desserré	Looser Verankerungsrahmen	Loosened anchorage frame	Marco de anclaje de desapriete	Quadro di ancoraggio allentato	Quadro de amarração solto	Отсоединенная анкерная рама
	Levage	Heben	Hoisting	Elevación	Sollevamento	Elevação	Подъем
	Distribution	Katzfahren	Trolleying	Distribución	Distribuzione	Distribuição	Перемещение по стреле
	Orientation	Schwenken	Slewing	Orientación	Rotazione	Rotação	Поворот
	Translation	Kranfahren	Travelling	Traslación	Traslazione	Translação	Перемещение крана
	Puissance nominale	Nennleistung	Rated power	Potencia nominal	Potenza nominale	Potência nominal	Номинальная мощность
	Nous consulter	Auf Anfrage	Consult us	Consultarnos	Consultateci	Consultar-nos	Проконсультируйтесь у нас

	Document commercial non contractuel. Pour toute information technique se référer à la notice correspondante.	Unverbindliches Vertriebsdokument. Für technische Informationen, siehe die entsprechenden Anweisungen.	This commercial document is not legally binding. For any technical information, please refer to the corresponding instructions.	Documento comercial no contractual. Para cualquier información técnica, ver la noticia correspondiente.	Documento commerciale non vincolante, per tutte le informazioni tecniche fare riferimento al catalogo istruzioni.	Documento comercial não contractual. Para qualquer informação técnica complementar consultar as respectivas instruções.	Этот коммерческий документ не является юридически обязательным. Для получения технической информации, см. соответствующие инструкции.
--	--	--	---	---	---	---	---

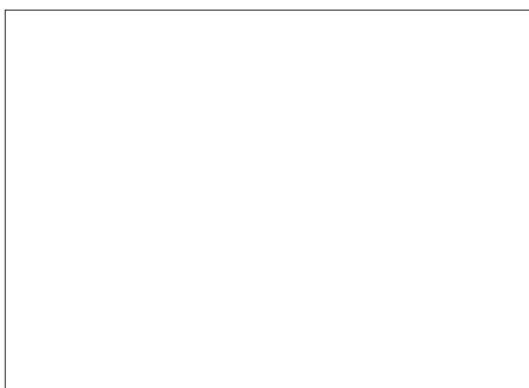

[www.manitowoc.com](http://www.manitowoc.com)

**Americas**  
**Manitowoc, Wisconsin, USA**  
 Tel: +1 920 684 6621  
 Fax: +1 920 683 6277

**Shady Grove, Pennsylvania, USA**  
 Tel: +1 717 597 8121  
 Fax: +1 717 597 4062

**Europe, Middle East, Africa**  
**Ecully, France**  
 Tel: +33 (0)4 72 18 20 20  
 Fax: +33 (0)4 72 18 20 00

**China**  
**Shanghai, China**  
 Tel: +86 21 6457 0066  
 Fax: +86 21 6457 4955

**Greater Asia-Pacific**  
**Singapore**  
 Tel: +65 6264 1188  
 Fax: +65 6862 4040